

**Sogang University BK Intelligence System
Semiconductor Invited Seminar
LLM & genAI - Technology, Industry, and Some
Important Questions**

Sunghee Yun

Co-founder / CAIO - AI Technology & Product Strategy

Erudio Bio, Inc.

About Speaker

- *Co-founder / CAIO - AI Technology & Product Strategy @ Erudio Bio, Inc., CA*
- Advisory Professor, Electrical Engineering and Computer Science @ DGIST, Korea
- Adjunct Professor, Electronic Engineering Department @ Sogang University, Seoul
- Technology Consultant @ Gerson Lehrman Group (GLG), NYC, USA
- *Co-founder / CTO & Chief Applied Scientist @ Gauss Labs Inc., Palo Alto, CA ~ 2023*
- Senior Applied Scientist @ Amazon.com, Inc., Vancouver, BC, Canada ~ 2020
- Principal Engineer @ Software R&D Center of Samsung DS Division, Korea ~ 2017
- Principal Engineer @ Strategic Marketing Team of Memory Business Unit ~ 2016
- Principal Engineer @ Memory DT Team of DRAM Development Lab. ~ 2015
- Senior Engineer @ CAE Team of Samsung Semiconductor ~ 2012
- M.S. & Ph.D. - Electrical Engineering (EE) @ Stanford University ~ 2004
- B.S. - Electrical Engineering (EE) @ Seoul National University ~ 1998

Exciting career journey

- B.S. - EE @ SNU & M.S. & Ph.D. - EE @ Stanford Univ.
 - *Convex Optimization - theory / algorithms / applications - under supervision of Prof. Stephen P. Boyd*
 - connectionists were depressed . . .
- Principal Engineer @ Memory Design Technology Team
 - develop variety of optimization tools for & and partner with *DRAM / NAND Flash / PE / Test Teams*
- Senior Applied Scientist @ Amazon
 - *SGoal project (ordered by Jeff Bezos) - Amazon shopping app customer engagement opt using AI - increased by 200MM USD*
- Co-founder / CTO & Chief Applied Scientist @ Gauss Labs Inc.
 - *lead develop & productionize industrial AI products, team building*
 - market, product & investment strategies
- Co-founder / CAIO - AI Technology & Product Strategy @ Erudio Bio, Inc.
 - *biotech AI technology & products, team building*

Today

- AI trend and technology
 - large language model (LLM)
 - LLM & multimodality
 - *attention turns out to be way more crucial*
. . . than even original authors envisioned!
 - generative AI (genAI) - models, and applications
- industry and business market impacts
 - business applications, and products
- some important topics & questions around future of AI
 - why human-level performance?
 - AI ethics, law, biases, consciousness
 - utopia / dystopia? and . . . way more important and critical problems

Takeaways and questions

- purpose of this talk is to answer questions such as
 - what are LLM & genAI and how do they work?
 - what is *secret sauce for LLM*?
 - why is multimodal learning important?
 - *industry trend & market and social impacts of AI*
 - how AI products will change our lives?
- and to *make the audience curious about and informed of topics like*
 - what are the things that we should be cautious of with AIs?
 - how can we prevent potential harms of AI?
 - how can / should we prepare for unprecedented changes by AI?
 - (philosophical) questions like . . . is AI intelligent? knowledgable?

Technology

Large Language Models

History of language models

- bag of words - first introduced - 1954
- word embedding - 1980
- RNN based models
- LSTM (based on RNN) - 1997
- 380M-sized seq2seq model using LSTMs proposed - 2014
- 130M-sized seq2seq model using gated recurrent units (GRUs)
- Transformer - Attention is All You Need (by A. Vaswani) - 2017
 - 100M-sized encoder-decoder multi-head attention model
 - remove recurrent architecture, handling arbitrarily long dependencies
 - parallelizable, simple linear-function-based attention model

Recent advances in speech & language processing

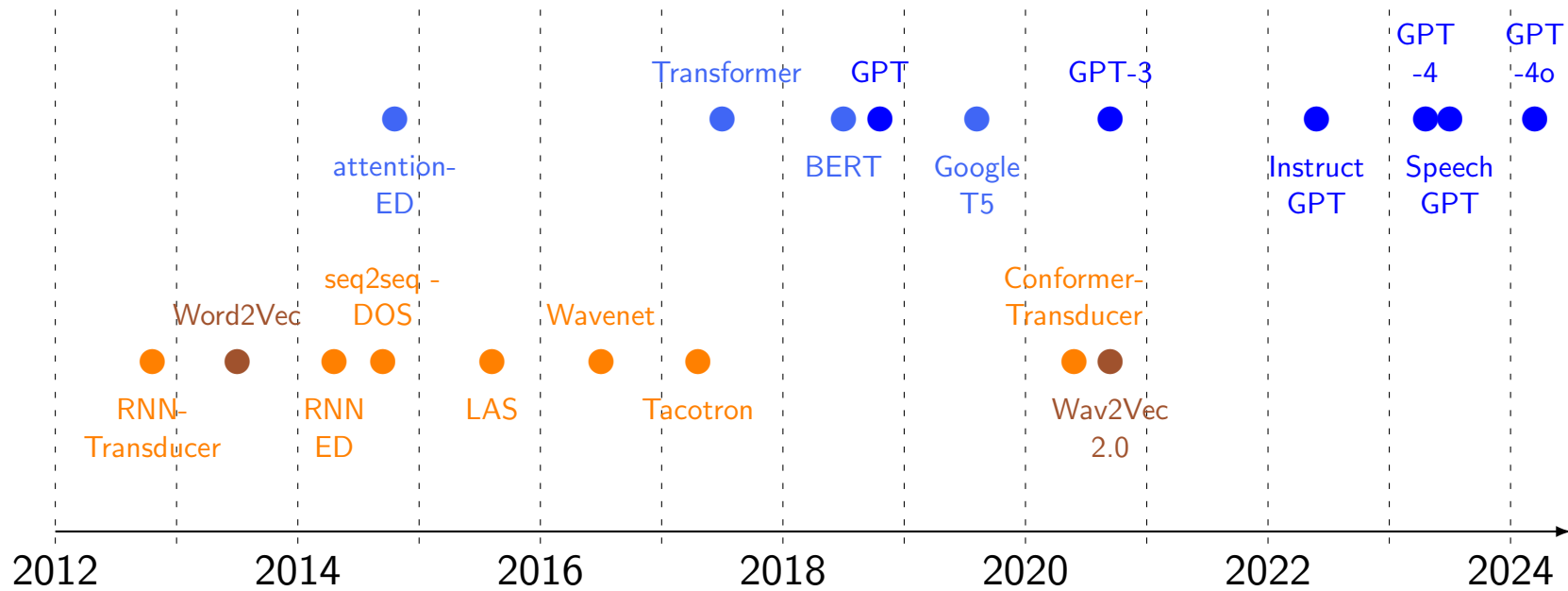

- LAS: listen, attend, and spell, ED: encoder-decoder, DOS: decoder-only structure

RNN-type sequence to sequence (seq2seq) model

- seq2seq - take sequences as inputs and spit out sequences
- encoder-decoder architecture

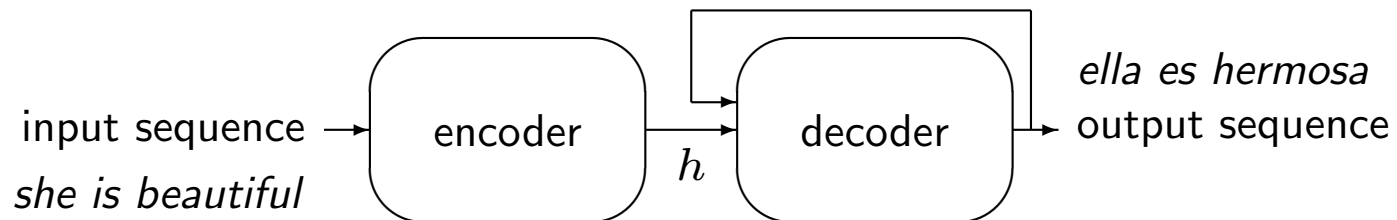

- encoder & decoder is RNN-type model
- $h \in \mathbf{R}^e$ - hidden state - *fixed length* vector
- (try to) condense and store information of input sequence (losslessly) in (fixed-length) hidden states
 - not flexible enough, *i.e.*, cannot deal with arbitrarily long sequences,
 - memory loss for long sequences
 - LSTM was promising fix, but with (inevitable) limits

RNN-type encoder-decoder example

- RNN can be basic RNN, LSTM, GRU, *etc.*

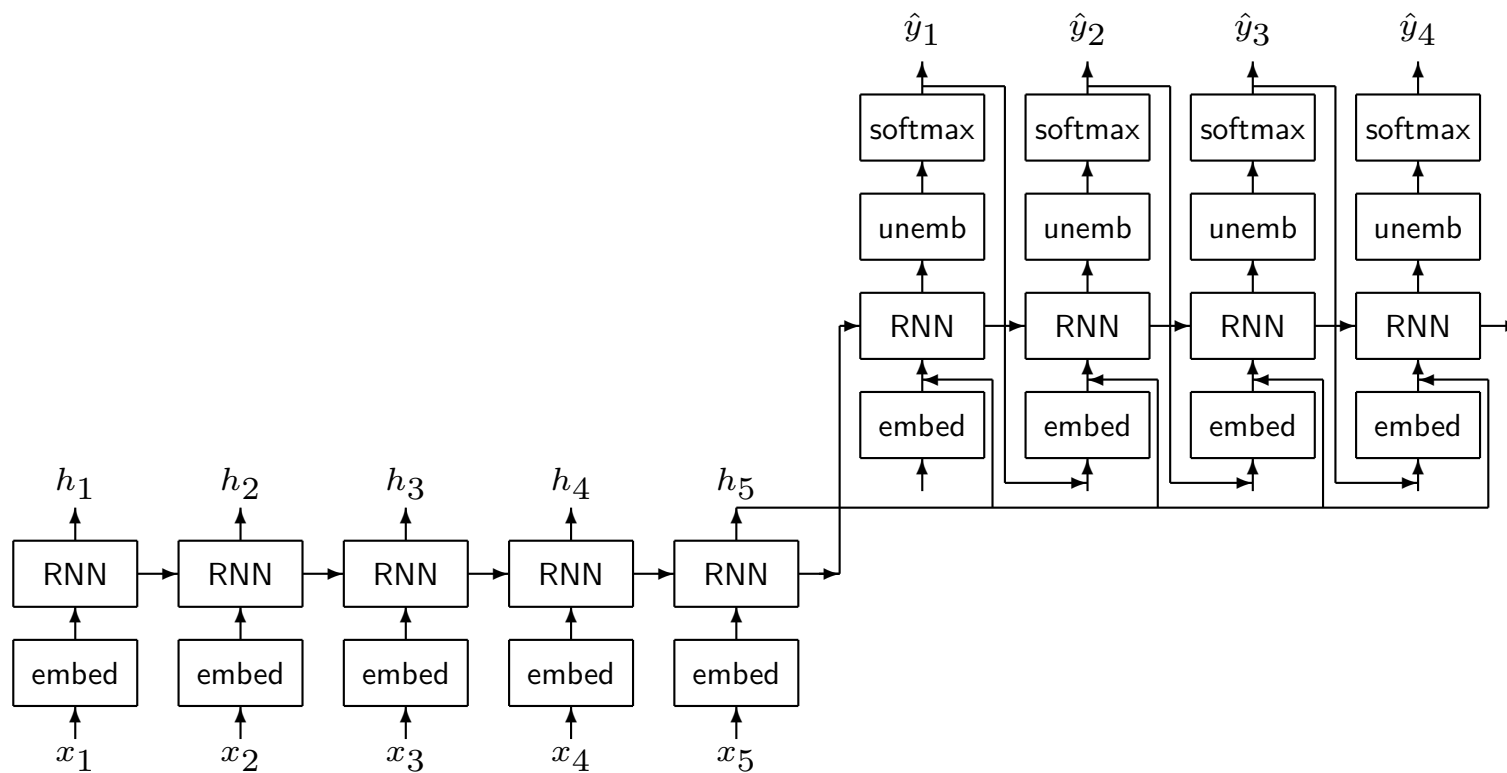

Shared encoder/decoder model

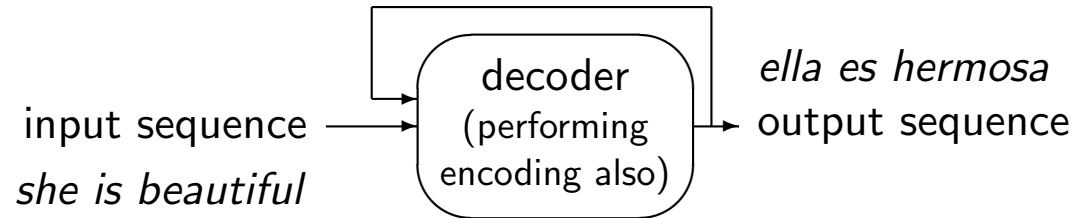

- may use single structure to perform both encoding & decoding
- LLMs are built in this way

Large language model (LLM)

- LLM
 - type of AI aimed for NLP trained on massive corpus of texts & programming code
 - allow learn statistical relationships between words & phrases, *i.e.*, conditional probabilities
 - *amazing performance shocked everyone - unreasonable effectiveness of data (Halevry et al, 2009)*
- applications
 - conversational AI agent / virtual assistant
 - machine translation / text summarization / content creation / sentiment analysis
 - code generation
 - market research / legal service / insurance policy / triange hiring candidates
 - + virtually infinite # of applications



LLMs

- Foundation Models
 - GPT-x/Chat-GPT - OpenAI, Llama-x - Meta, PaLM-x (Bard) - Google
- # parameters
 - generative pre-trained transformer (GPT) - GPT-1: 117M, GPT-2: 1.5B, GPT-3: 175B, GPT-4: 100T, GPT-4o: 200B
 - large language model Meta AI (Llama) - Llama1: 65B, Llama2: 70B, Llama3: 70B
 - scaling language modeling with pathways (PaLM) - 540B
- burns lots of cash on GPUs!
- applicable to many NLP & genAI applications

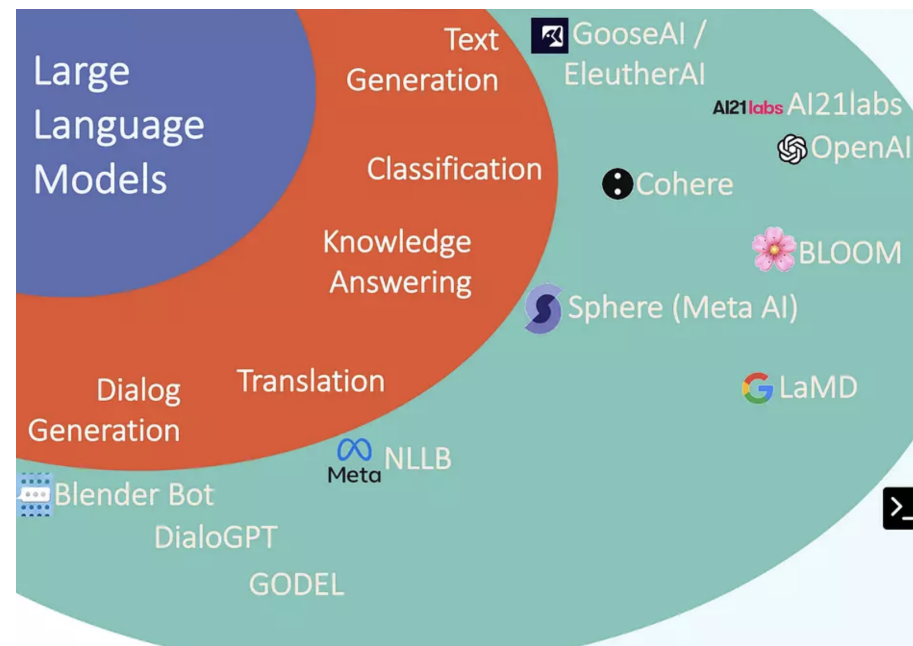

LLM building blocks

- data - trained on massive datasets of text & code
 - quality & size critical on performance
- architecture - GPT/Llama/Mistral
 - can make huge difference
- training - self-supervised/supervised learning
- inference - generates outputs
 - in-context learning, prompt engineering

goal and scope of LLM project

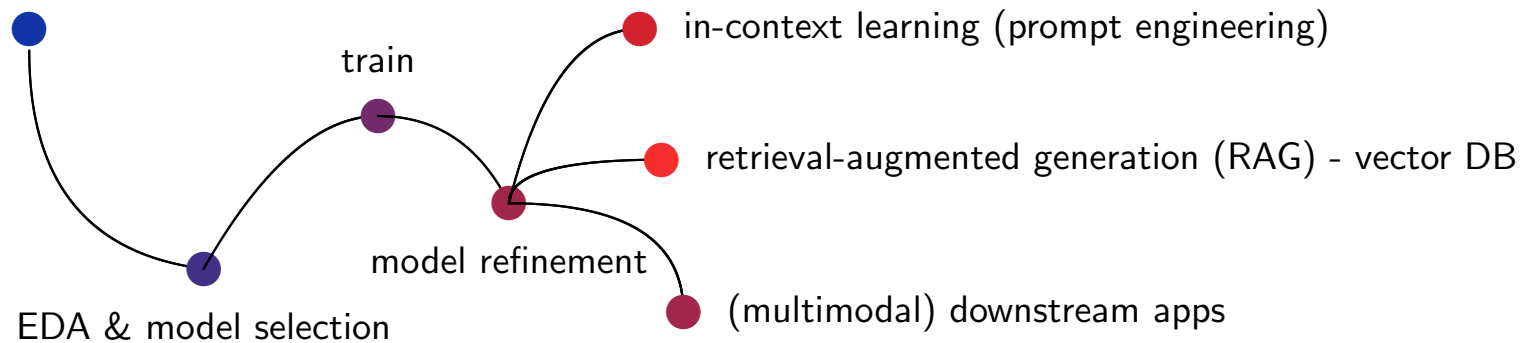

LLM architectural secret (or known) sauce

Transformer - simple parallelizable attention mechanism

A. Vaswani, et al. Attention is All You Need, 2017

Transformer architecture

- encoding-decoding architecture
 - input embedding space → multi-head & multi-layer representation space → output embedding space
- additive positional encoding - information regarding order of words @ input embedding
- multi-layer and multi-head attention followed by addition / normalization & feed forward (FF) layers
- *(relatively simple) attentions*
 - single-head (scaled dot-product) / multi-head attention
 - self attention / encoder-decoder attention
 - masked attention
- benefits
 - *evaluate dependencies between arbitrarily distant words*
 - has recurrent nature w/o recurrent architecture → parallelizable → fast w/ additional cost in computation

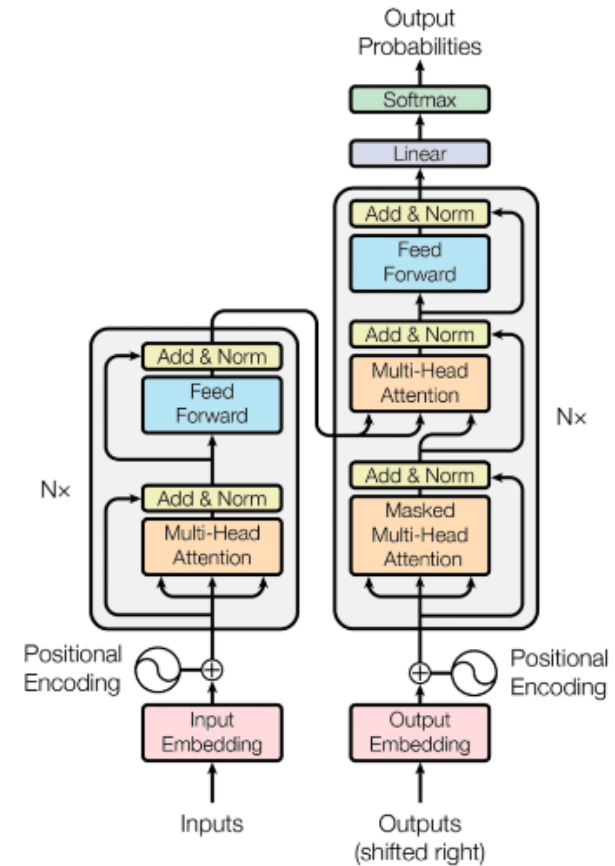

Single-head scaled dot-product attention

- Here values / keys / queries denote value / key / query *vectors* and d_k & d_v are lengths of keys / queries & vectors respectively
- Also we use standard linear algebra notions for matrices and vectors - not transposed version that (almost) all ML scientists (wrongly) use
- output: weighted-average of values where weights are attentions / dependencies among tokens
- assume n queries and m key-value pairs

$$Q \in \mathbf{R}^{d_k \times n}, K \in \mathbf{R}^{d_k \times m}, V \in \mathbf{R}^{d_v \times m}$$

- attention! outputs n values (since we have n queries)

$$\text{Attention}(Q, K, V) = V \text{softmax} \left(K^T Q / \sqrt{d_k} \right) \in \mathbf{R}^{d_v \times n}$$

- *much simpler attention mechanism than previous work*
 - attention weights were output of complicated non-linear NN

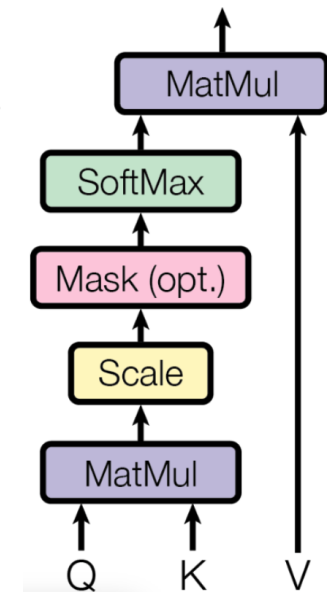

Single-head - close look at equations

- focus on i th query, $q_i \in \mathbf{R}^{d_k}$, $Q = [\quad q_i \quad] \in \mathbf{R}^{d_k \times n}$
- assume m keys and m values, $k_1, \dots, k_m \in \mathbf{R}^{d_k}$ & $v_1, \dots, v_m \in \mathbf{R}^{d_v}$

$$K = [k_1 \quad \dots \quad k_m] \in \mathbf{R}^{d_k \times m}, V = [v_1 \quad \dots \quad v_m] \in \mathbf{R}^{d_v \times m}$$

- then

$$K^T Q / \sqrt{d_k} = \begin{bmatrix} - & \vdots & - \\ - & k_j^T q_i / \sqrt{d_k} & - \\ - & \vdots & - \end{bmatrix}$$

e.g., dependency between i th output token and j th input token is

$$a_{ij} = \exp \left(k_j^T q_i / \sqrt{d_k} \right) / \sum_{j=1}^m \exp \left(k_j^T q_i / \sqrt{d_k} \right)$$

- value obtained by i th query, q_i in $\text{Attention}(Q, K, V)$

$$a_{i,1}v_1 + \dots + a_{i,m}v_m$$

Multi-head attention

- evaluate h single-head attentions (in parallel)
- d_e : dimension for embeddings
- embeddings

$$X \in \mathbf{R}^{d_e \times m}, Y \in \mathbf{R}^{d_e \times m}, Z \in \mathbf{R}^{d_e \times n}$$

e.g., n : input sequence length & m : output sequence length in machine translation

- h key/query/value weight matrices: $W_i^K, W_i^Q \in \mathbf{R}^{d_k \times d_e}$, $W_i^V \in \mathbf{R}^{d_v \times d_e}$ ($i = 1, \dots, h$)
- linear output layers: $W^O \in \mathbf{R}^{d_e \times h d_v}$
- **multi-head attention!**

$$W^O \begin{bmatrix} A_1 \\ \vdots \\ A_h \end{bmatrix} \in \mathbf{R}^{d_e \times n},$$

$$A_i = \text{Attention}(W_i^Q Z, W_i^K Y, W_i^V X) \in \mathbf{R}^{d_v \times n}$$

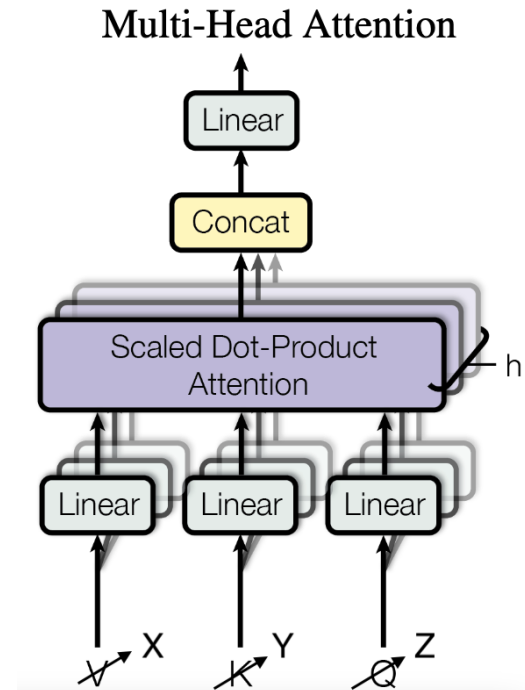

Self attention

- $m = n$
- encoder
 - keys & values & queries (K, V, Q) come from same place (from previous layer)
 - every token attends to every other token in input sequence
- decoder
 - keys & values & queries (K, V, Q) come from same place (from previous layer)
 - every token attends to other tokens up to that position
 - prevent leftward information flow to right to preserve causality
 - assign $-\infty$ for illegal connections in softmax (masking)

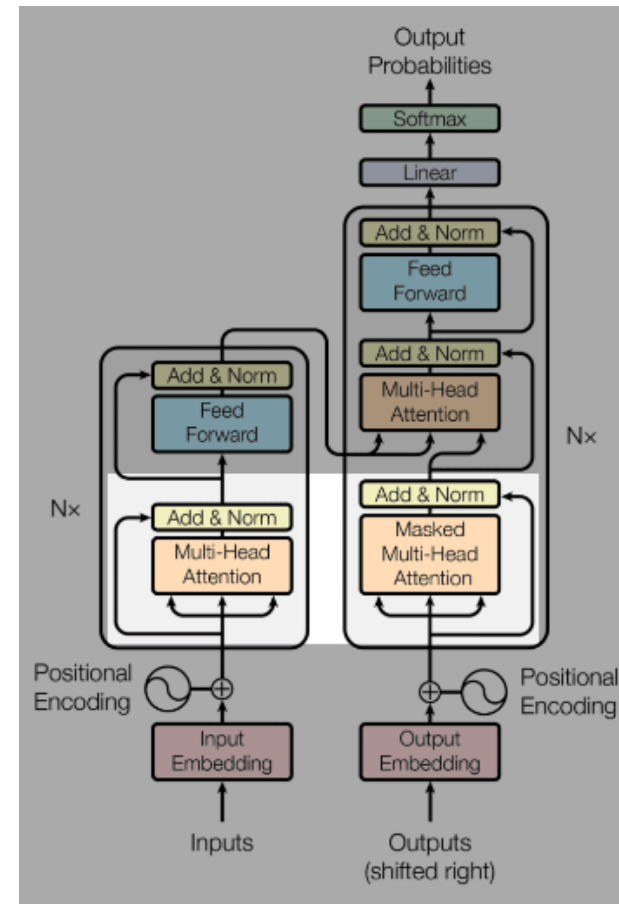

Encoder-decoder attention

- m : length of input sequence
- n : length of output sequence
- n queries (Q) come from previous decoder layer
- m keys / m values (K, V) come from output of encoder
- every token in output sequence attends to every token in input sequence

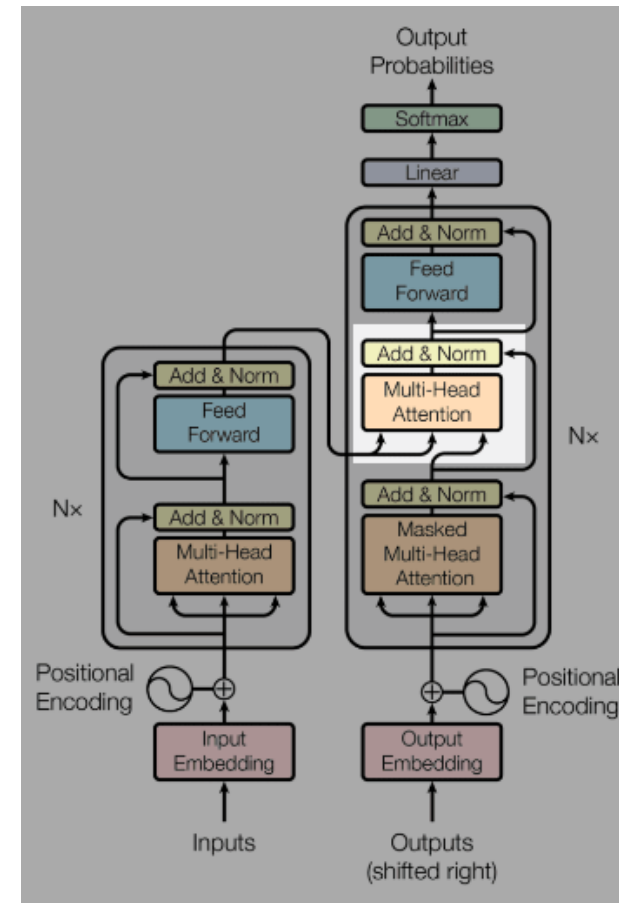

Visualization of self attentions

example sentence

“It is in this spirit that a majority of American governments have passed new laws since 2009 making the registration or voting process more difficult.”

- self attention of encoder (of a layer)
 - right figure
 - show dependencies between “making” and other words
 - different columns of colors represent different heads
 - “making” has strong dependency to “2009”, “more”, and “difficult”

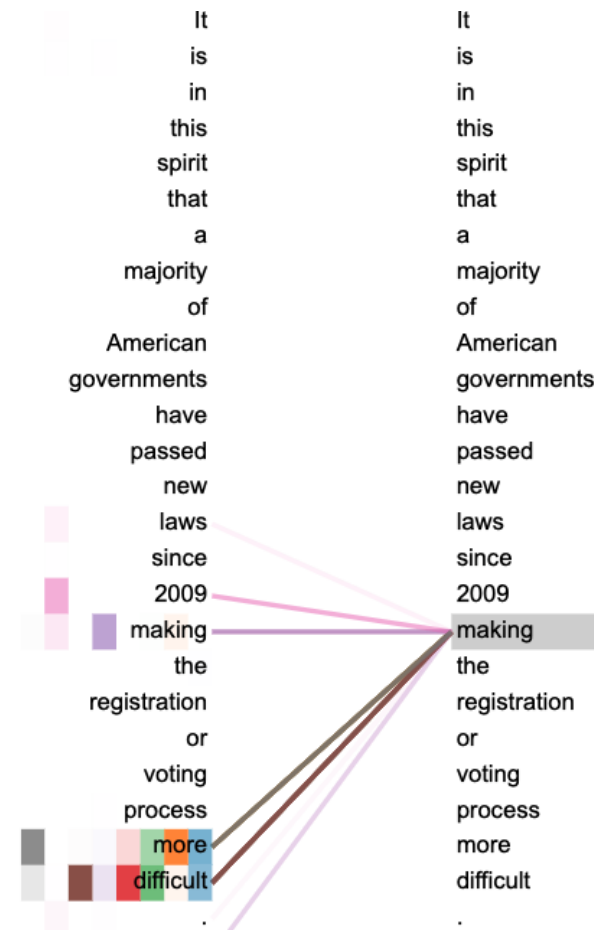

Visualization of multi-head self attentions

- self attentions of encoder for two heads (of a layer)
 - different heads represent different structures
→ advantages of multiple heads
 - multiple heads work together to collectively yield good results
 - dependencies *not* have absolute meanings (like embeddings in collaborative filtering)
 - randomness in resulting dependencies exists due to stochastic nature of ML training

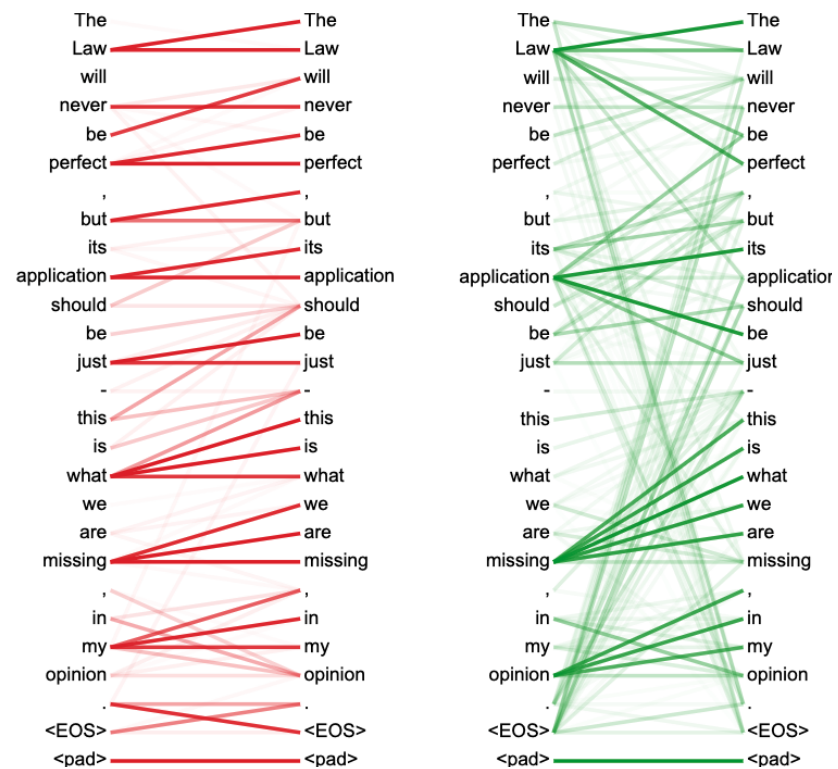

Visualization of encoder-decoder attentions

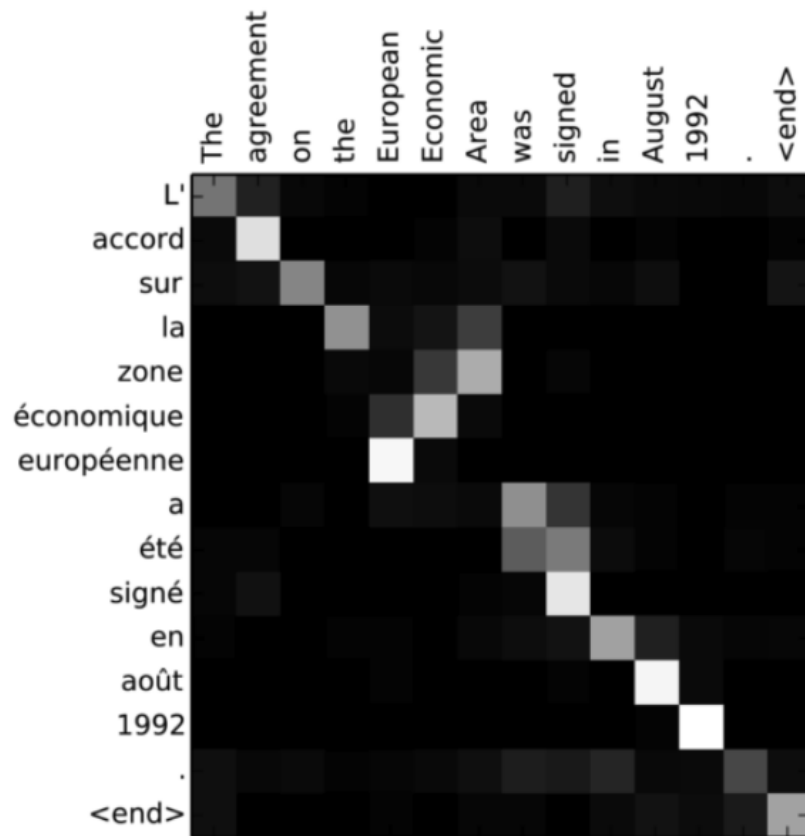

- machine translation: English → French
 - input sentence: “The agreement on the European Economic Area was signed in August 1992.”
 - output sentence: “L’ accord sur la zone économique européenne a été signé en août 1992.”
- encoder-decoder attention reveals relevance between
 - European ↔ européenne
 - Economic ↔ européenne
 - Area ↔ zone

Model complexity

- computational complexity
 - n : sequence length, d : embedding dimension
 - complexity per layer - self-attention: $\mathcal{O}(n^2d)$, recurrent: $\mathcal{O}(1)$
 - sequential operations - self-attention: $\mathcal{O}(1)$, recurrent: $\mathcal{O}(n)$
 - maximum path length - self-attention: $\mathcal{O}(1)$, recurrent: $\mathcal{O}(n)$
- *massive parallel processing, long context windows*
 - *makes NVidia more competitive, hence profitable!*
 - *makes SK Hynix prevail HBM market!*

Derivatives of Transformer - BERT

- Bidirectional Encoder Representations from Transformers
- pre-train deep bidirectional representations from unlabeled text
- fine-tunable for multiple purposes

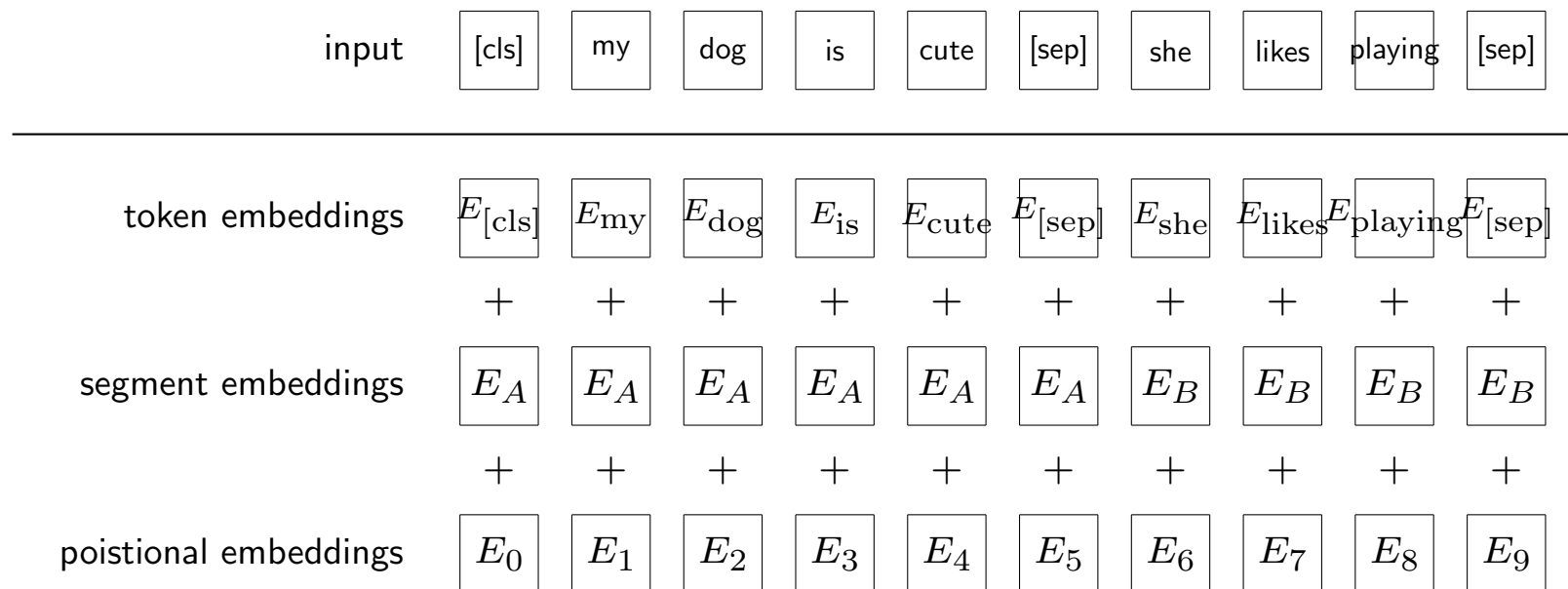

Multimodal learning

- understand information from multiple modalities, *e.g.*, text, images, audio, and video
- representation learning
 - language representation + image / video / text / audio representation
 - learn multimodal representations together
- outputs
 - captions for images, videos with narration, musics with lyrics
- collaboration among different modalities
 - understand image world (open system) using language (closed system)



Implications of success of LLMs

- (very) many researchers change gears towards LLM
 - from computer vision (CV), speech, music, video, even reinforcement learning
- *LLM is not (only) about languages . . .*
 - humans have . . .
 - evolved and optimized (natural) language structures for eons
 - handed down knowledge using natural languages for thousands of years
 - natural language optimized (in human brains) through *thousands of generation by evolution*
 - *can connect non-linguistic world (open system) using language structures (closed system)*

Challenges in LLMs

- *hallucination - can give entirely plausible outcome that is false*
- data poison attack
- unethical or illegal content generation
- huge resource necessary for both training & inference
- model size - need compact models
- outdated knowledge - can be couple of years old
- lack of reproducibility
- *biases - more on this later . . .*

do not, though, focus on downsides but on *infinite possibilities!*

- it evolves like internet / mobile / electricity
- only “tip of the iceberg” found & released

Generative AI

Generative AI (genAI)

- definition of generative model

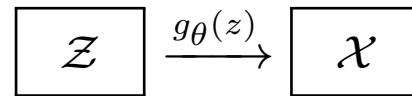

- *generate samples in original space, \mathcal{X} , from samples in latent space, \mathcal{Z}*
- g_{θ} is parameterized model *e.g.*, CNN / RNN / Transformer / diffusion-based model
- training
 - finding θ that minimizes/maximizes some (statistical) loss/merit function so that $\{g_{\theta}(z)\}_{z \in \mathcal{Z}}$ generates plausible point in \mathcal{X}
- inference
 - random samples z to generated target samples $x = g_{\theta}(z)$
 - *e.g.*, image, text, voice, music, video

VAE - early genAI model

- variational auto-encoder (VAE)

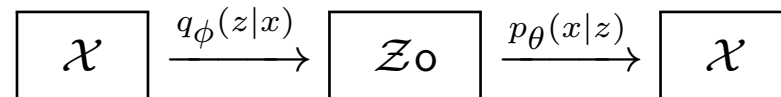

- log-likelihood & ELBO - for any $q_\phi(z|x)$

$$\begin{aligned} \log p_\theta(x) &= \mathbf{E}_{z \sim q_\phi(z|x)} \log p_\theta(x) = \mathbf{E}_{z \sim q_\phi(z|x)} \log \frac{p_\theta(x, z)}{q_\phi(z|x)} \cdot \frac{q_\phi(z|x)}{p_\theta(z|x)} \\ &= \mathcal{L}(\theta, \phi; x) + D_{KL}(q_\phi(z|x) \| p_\theta(z|x)) \geq \mathcal{L}(\theta, \phi; x) \end{aligned}$$

- (indirectly) maximize likelihood by maximizing evidence lower bound (ELBO)

$$\mathcal{L}(\theta, \phi; x) = \mathbf{E}_{z \sim q_\phi(z|x)} \log \frac{p_\theta(x, z)}{q_\phi(z|x)}$$

- generative model

$$p_\theta(x|z)$$

GAN - early genAI model

- generative adversarial networks (GAN)

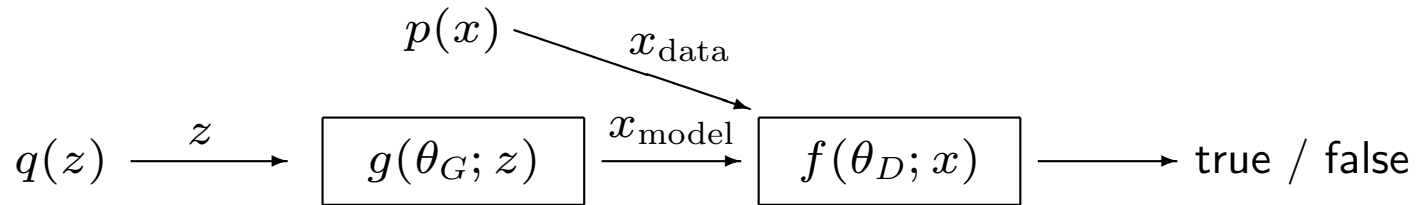

- value function

$$V(\theta_D, \theta_G) = \mathbf{E}_{x \sim p(x)} \log f(\theta_D; x) + \mathbf{E}_{z \sim q(z)} \log(1 - f(\theta_D; g(\theta_G; z)))$$

- modeling via playing min-max game

$$\min_{\theta_G} \max_{\theta_D} V(\theta_D, \theta_G)$$

- generative model

$$g(\theta_G; z)$$

- variants: conditional / cycle / style / Wasserstein GAN

genAI - LLM

- *maximize conditional probability*

$$\text{maximize}_{\theta} d(p_{\theta}(x_t|x_{t-1}, x_{t-2}, \dots), p_{\text{data}}(x_t|x_{t-1}, x_{t-2}, \dots))$$

where $d(\cdot, \cdot)$ distance measure between probability distributions

- previous sequence: x_{t-1}, x_{t-2}, \dots
- next token: x_t
- p_{θ} represented by (extremely) complicated model
 - *e.g.*, containing multi-head & multi-layer Transformer architecture inside
- model parameters, *e.g.*, for Llama2

$$\theta \in \mathbf{R}^{70,000,000,000}$$

genAI applications

- ChatGPT, Cohere
- Anthropic, Dolly, Mosaic MPT
- LangChain, Vertex AI, HuggingFace, Whisper
- Stable Diffusion
- Midjourney, DALL-E, LLaMA 2
- Mistral AI, Amazon Bedrock, and Falcon.



AI Research

AI research race gets crazy

- practically impossible to follow all developments announced everyday
 - new announcement and publication of important work everyday!
- industry leads research - academia lags behind
 - could be predicted before 2015
- everyone excited to show off their work to the world
 - biggest driving force behind unprecedented scale and speed of advancement of AI together with massive investment of capitalists



AI progress within a month - March, 2024

- UBTECH Humanoid Robot Walker S: Workstation Assistant in EV Production Line
- H1 Development of dance function
- Robot Foundation Models (Large Behavior Models) by Toyota Research Institute (TRI)
- Apple Vision Pro for Robotics
- Figure AI & OpenAI
- Human modeling
- LimX Dynamics' Biped Robot P1 Conquers the Wild Based on Reinforcement Learning
- HumanoidBench: Simulated Humanoid Benchmark for Whole-Body Locomotion and Manipulation - UC Berkeley & Yonsei Univ.
- Vision-Language-Action Generative World Model
- RFM-1 - Giving robots human-like reasoning capabilities

Papers published in single AI conference by single company - CVPR 2024

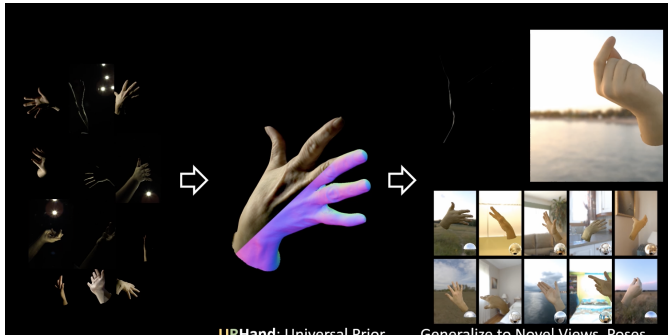

- PlatoNeRF: 3D Reconstruction in Plato's Cave via Single-View Two-Bounce Lidar - MIT, Codec Avatars Lab, & Meta
 - 3D reconstruction from single-view
- Nymeria Dataset
 - large-scale multimodal egocentric dataset for full-body motion understanding
- Relightable Gaussian Codec Avatars - Codec Avatars Lab & Meta
 - build high-fidelity relightable head avatars being animated to generate novel expressions
- Robust Human Motion Reconstruction via Diffusion (RoHM) - ETH Zürich & Reality Labs Research, Meta
 - robust 3D human motion reconstruction from monocular RGB videos

AI Market

genAI products

- DALL-E (OpenAI)
 - trained on a diverse range of images
 - *generate unique and detailed images based on textual descriptions*
 - understanding context and relationships between words
- Midjourney
 - let people *create imaginative artistic images*
 - can interactively guide the generative process, providing high-level directions



genAI products



- Dream Studio
 - enables people to create music
 - *analyze patterns in music data and generates novel compositions based on input and style*
 - *allows musicians to explore new ideas and enhance their creative processes*
 - offer open-source free version
- Runway
 - provide range of generative AI tools for creative professionals
 - realistic images, manipulate photos, create 3D models, automate filmmaking, . . .
 - “artificial intelligence brings automation at every scale, introducing dramatic changes in how we create”

AI products

Audio: music generation

Combined funding \$ 61M

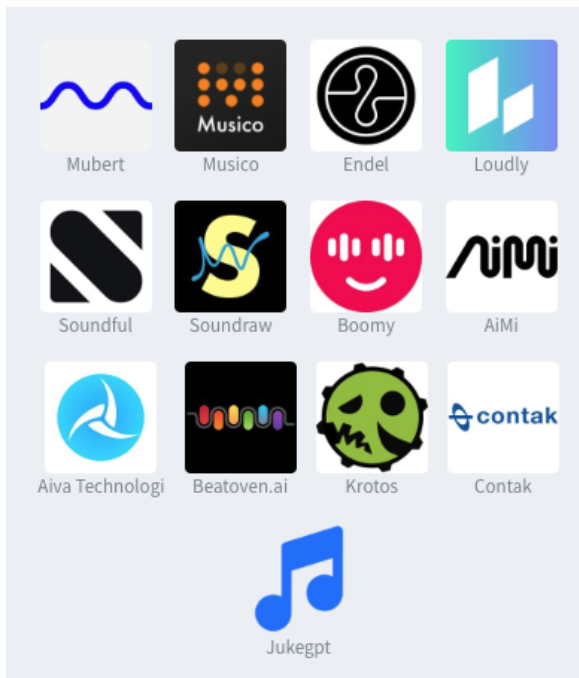

Video

Combined funding \$ 428M

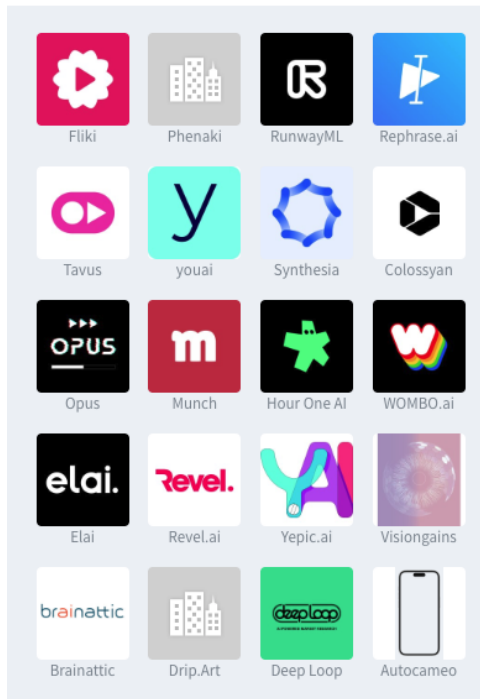

Text: copy & writing

Combined funding \$ 863M

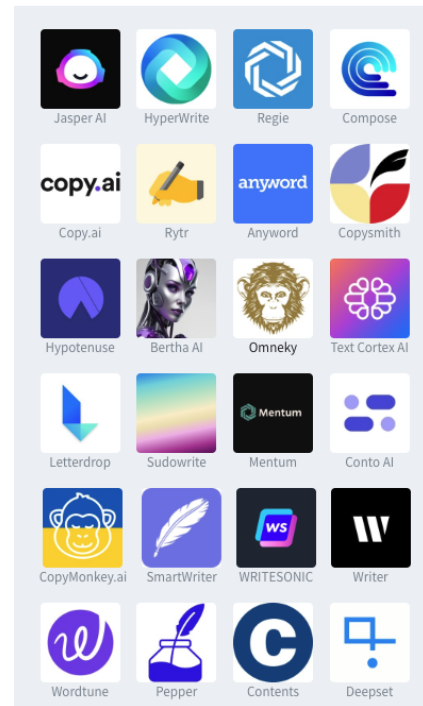

AI products

LLMs tools: Prompt Engineering and Management

Combined funding \$ 7.5M

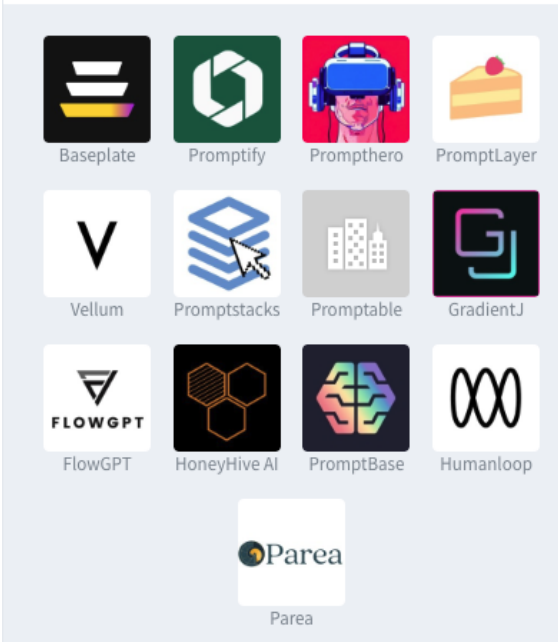

Gaming & design: 3d assets & worlds

Combined funding \$ 117M

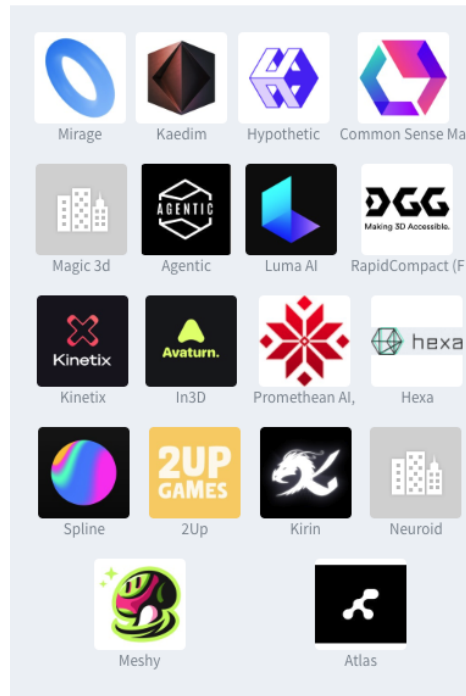

Code: code generation

Combined funding \$ 828M

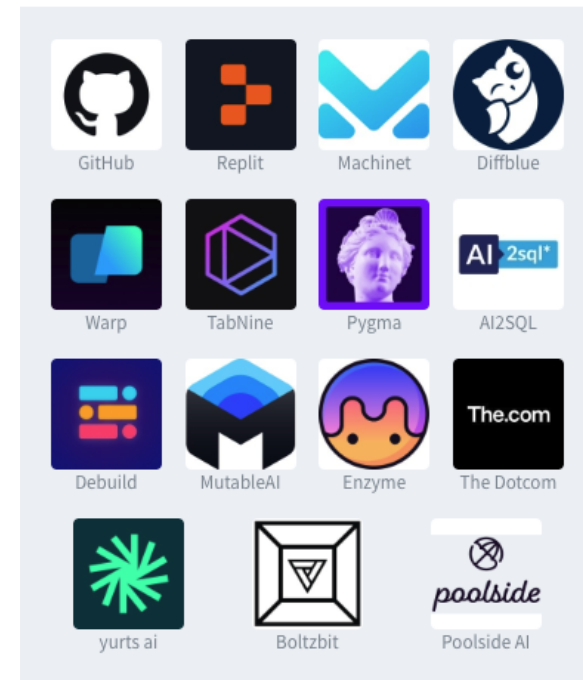

AI companies

- big tech companies
 - OpenAI, Microsoft, Google, Meta - foundation models
- small(er) players
 - Figure AI, Mistral AI
- AI hardware companies - benefiting from LLM and genAI market dominance
 - Nvidia, AMD, Samsung, SK hynix, Micron, Intel, TSMC (AI processors & memory chips)
- *tiny fraction of Silicon Valley startups gets majority of total funding*
 - Anthropic - \$3.5B - large-scale AI systems - Claude
 - AssemblyAI - \$58M - speech AI
 - Hugging Face - \$400M - AI model/data platforms
 - Inflection AI - \$1.5B - conversational AI - Pi

Opportunities among big tech's domination

- OpenAI/Microsoft, Meta, Google's races for foundation models heated up!
- no small players can compete with rare exceptions, *e.g.*, Mistral AI
- hyperscalers stand strong - AWS, Azure, and Google Cloud
- *speaker's proposals for strategies*
 - accurately (or roughly) predict how far & up to where big players will reach
 - target niche markets
 - focus on (creative) downstream applications of LLMs and/or genAIs

AI market outlook in 2024

- global AI market expected to reach \$0.5T by 2024 (by IDC, 15-Mar-2023, yahoo! finance)
- *AI funding soars to \$17.9B for Q3 in 2023 in Silicon Valley while rest of tech slumps* (by PitchBook data, 17-Oct-2023, Bloomberg)
 - multibillion-dollar investment in AI startups almost commonplace in Silicon Valley
 - genAI dazzles users and investors with photo-realistic images & human-sounding text
- genAI software sales could surge *18,647% by 2032*

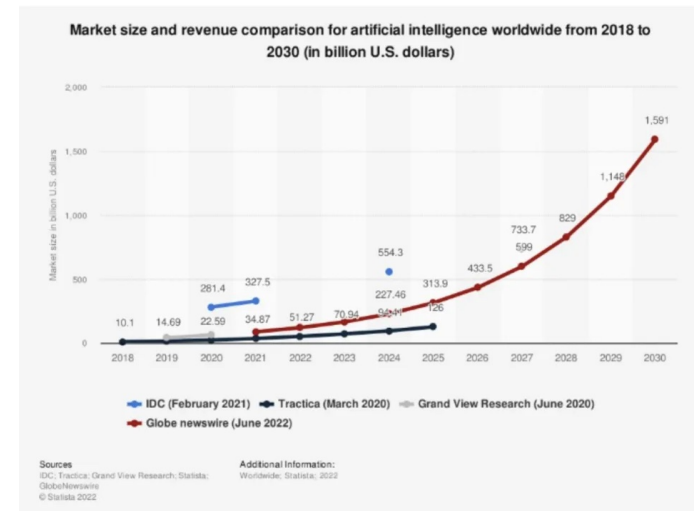

Global Semiconductor Markets

Hard-to-predict global semiconductor markets

- CHIPS for America Act - semiconductor manufacturing reshoring by US
 - ask (or coerce) world-best semiconductor companies build factories in US while state support
- US government awards
 - \$1.5B - Global Foundry - @ Feb-2024
 - \$0.685B - SK Hynix - Lafayette, Indiana (Silicon Heartland) @ Apr-2024 - next-generation memory chips for AI investing \$4B
 - \$6.4 - Samsung - Tolor, Texas @ Apr-2024 - chips for automotive, consumer technology, IoT, aerospace, *etc.* investing \$40B
 - ?? - TSMC - Arizona - Foundry
 - 50 MM funding - small biz research and development
- TSMC's presence in Japan - backed by government

Hard-to-predict AI hardware markets

- US traditionally strong in design houses
 - Nvidia, Apple, . . . , Amazon, Meta, . . .
- threatened by vulnerable supply chains experienced in COVID period → reshoring
- NOW *want to make chips themselves! - can and will reshape AI hardware industry*
- Intel declares seriousness about foundry business!
- Nvidia challenged!
 - many companies including AMD starting share AI chips markets
 - big techs start making their own hardware

AMD - Nvidia's new competitor

- Instinct MI300X - launched on 06-Dec-2023
 - 50% more HBM3 capacity than its predecessor, MI250X (128 GB)
 - *outperform Nvidia's H100 TensorRT-LLM* (when using optimized AI software stack)
 - 1.6X Higher Memory Bandwidth - 1.3X FP16 TFLOPS
 - up to 40% faster vs H100 (Llama 2 70B) in 8v8 server
- already dopted by customer, LaminiAI backed by AMD
- *great timing when Nvidia's order backlogs stuck*
- AMD stocks soars as of Jan-2024
- Lisa Su categorizes them as next big thing in tech industry
- potential risks: ROCm vs CUDA, speed of customer adoption, production coverage

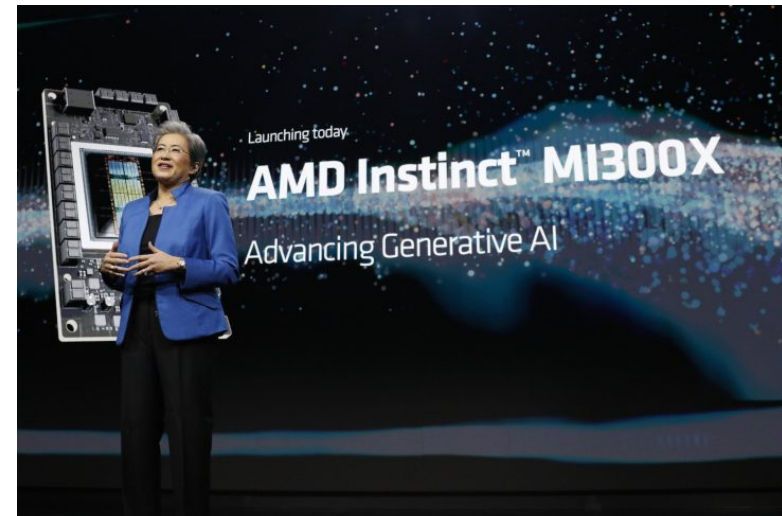

Serendipities around AIs

Serendipity or Inevitability

- What if Hinton had not been persistent researcher?
- What if symbolist won over connectionists?
- What if attention mechanism did not perform well?
- What if Transformer architecture did not perform super well?
- What if Jensen Hwang had not been crazy about making hardware for professional gamers?
- Is it like Alexander Fleming's Penicillin?
- Or more like Inevitability?

Some Important Questions around AI

Some important questions around AI

- why human-level AI in the first place?
- what is very core of DL architecture? why does it work amazingly well?
- biases that can hurt judgement, decision making, social good?
- ethical and legal issues
- consciousness, knowledge, belief, reasoning

Why human-level in the first place?

- lots of times, when we measure AI performance, we say
 - how can we achieve human-level performance, *e.g.*, CV models?
- why human-level?
 - are all human traits desirable?
 - are humans flawless?
 - aren't humans still evolving?
- advantage of AI over humans
 - *e.g.*, self-driving cars can use extra eyes, GPS, computer network
 - *e.g.*, recommendation system runs for hundreds of millions of people overnight
 - AI is available 24 / 7 while humans cannot
 - . . . critical advantages for medical assistance, emergency handling
 - AI does not make more mistakes because task is repetitive and tedious
 - AI does not request salary raise or go on strike

Cognitive biases

- confirmation bias, availability bias
- hindsight bias, confidence bias, optimistic bias
- anchoring bias, halo effect, framing effect, outcome bias
- belief bias, negativity bias, false consensus,

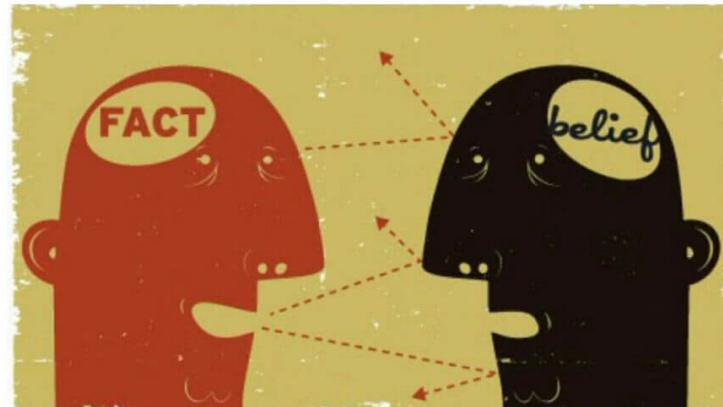

LLM biases

- plausible with LLM
 - availability bias - biased by imbalancedly available information
 - LLM trained by imbalanced \neq articles for specific topics
 - belief bias - derive conclusion not by reasoning, but by what it saw
 - LLM easily inferencing what it saw, *i.e.*, data it trained on
 - halo effect - overemphasize on what prestigious figures say
 - LLM trained by imbalanced \neq reports about prestigious figures
 - false consensus - overemphasize how much others share their beliefs & values
 - LLM trained by comments by opinionated commenters
- similar facts true for other types of ML models,
 - *e.g.*, video caption, text summarization, sentiment analysis
- cognitive biases only human represent
 - confirmation bias, hindsight bias, confidence bias, optimistic bias, anchoring bias, negativity bias, framing effect

Ethics - possibilities & questions

- AI can be exploited by those who have bad intention to
 - manipulate / deceive people - using manipulated data corpus for training
 - *e.g.*, spread false facts
 - induce unfair social resource allocation
 - *e.g.*, medical insurance, taxation
 - exploit advantageous social and economic power
 - *e.g.*, unfair wealth allocation, mislead public opinion
- AI for Good - advocated by Andrew Ng
 - *e.g.*, public health, climate change, disaster management
- should scientists and engineers be morally & politically conscious?
 - *e.g.*, Manhattan project

Legal issues with ethical consideration - (hypothetical) scenarios

- scenario 1: full self-driving algorithm causes traffic accident killing people
 - who is responsible? - car maker, algorithm developer, driver, algorithm itself?
- scenario 2: self-driving cars kill less people than human drivers
 - *e.g.*, human drivers kill 1.5 people for 100,000 miles & self-driving cars kill 0.2 people for 100,000 miles
 - how should law makers make regulations?
 - utilitarian & humanistic perspectives
- scenario 3: someone is not happy with their data being used for training
 - “The Times sues OpenAI and Microsoft over AI use of copyrighted work” (Dec. 2023)

Consciousness

- what is consciousness, anyway?
 - recognizes itself as independent, autonomous, valuable entity?
 - recognizes itself as living being, unchangeable entity?
 - will to survive?
- no agreed definition on consciousness exists yet
. . . and will be so forever
- can it be separated from fact that humans are biological living being?
 - (speaker) doesn't think so . . .
- is SKYNET ever plausible (without someone's intention)?
 - can AI have *desire* to survive (or save earth)?



Utopia or dystopia



- not important questions (speaker thinks)
 - what we should worry about is not doomday or destroying humankind
- but rather we should focus on
 - our limit in controlling or unintended consequences of AI
 - misuse by those possessing social, economic, political power
 - social good and welfair imparied by (exploting of) AI
 - choice among utilitarianism / humanism / justice / equity
 - handle ethical and legal issues

Other interesting questions

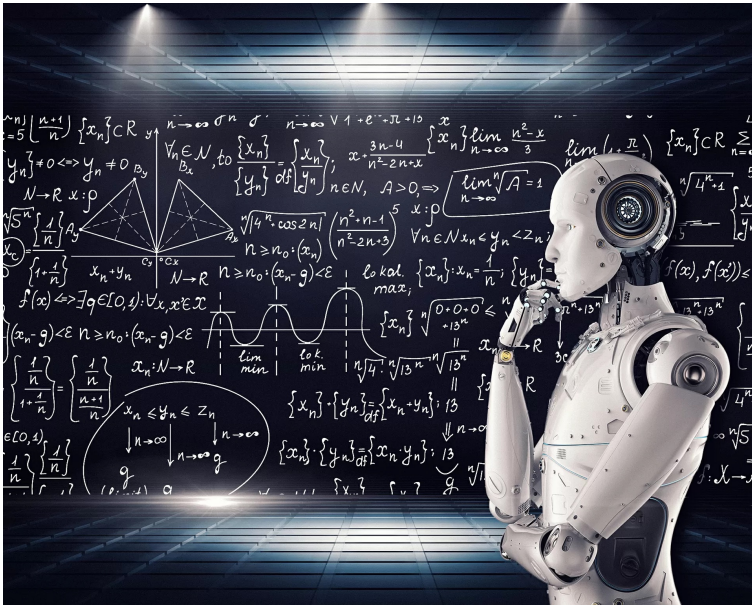

- *knowledge, belief, and reasoning of LLM/AI*
- is AI/LLM intelligent?
 - brain scientific perspective
 - cognitive-scientific perspective
- impacts on labor and job market
 - reality / optimism / pessimism / resolution / prediction
- how should we prepare for our own futures

Does LLM (or AI) have knowledge or belief? Can it reason?

What categories of questions should they be?

Philosophical? Cognitive scientific?

Three surprises of LLM

- LLM is very different sort of animal . . . except that it is *not* an animal!
- *unreasonable* effectiveness of data (Halevry et al, 2009)
 - *performance scales with size of training data*
 - *qualitative leaps* in capability as models scale
 - tasks demanding human intelligence *reduced to next token prediction*
- focus on third surprise
 - *“conditional probability model looks like human with intelligence”*
 - making vulnerable to anthropomorphism
- examine it by throwing questions
 - *“does LLM have knowledge and belief?”*
 - *“can it reason?”*

Knowledge, belief, & reasoning around LLM

- *not* easy topic to discuss, or even impossible because
 - we do *not* have agreed definition of these terms especially in context of being asked questions like

does ChatGPT have belief?

or

do humans have knowledge?

- let us discuss them in two different perspectives
 - laymen's perspective
 - cognitive scientific perspective

Laymen's perspective on knowledge / belief / reasoning

- does (good) LLM have knowledge?
 - Grandmother - looks like it cuz when instructed *“explaining big bang”*, it says
“ The Big Bang theory is prevailing cosmological model that explains the origin and evolution of the universe. . . . 13.8 billion years ago . . . ”
- does it have belief?
 - Grandmother: I don't think so, *e.g.*, it does not believe in God.
- can it reason?
 - Grandmother: seems like it! *e.g.*, when asked *“Sunghee is a superset of Alice and Beth is a superset of Sunghee. is Beth a superset of Alice?”*, it says
“ Yes, based on information provided, if Sunghee is a superset of Alice and Beth is a superset of Sunghee, then Beth is indeed a superset of Alice . . . ”
- can it reason to prove theorem whose inferential structure is more complicated?
 - Grandmother: I'm not sure. - actually, I don't know what you're talking about!

Cognitive scientific perspective on knowledge

- does LLM have knowledge?
 - Speaker: I don't think so.
- why?
 - Speaker: we say we have “knowledge” when *“we do so against ground of various human capacities that we all take for granted when we engage in everyday conversation with each other.”*
 - LLM cannot do this.
 - Speaker: also when asked *“who is Tom Cruise’s mother?”*, it says *“Tom Cruise’s mother is Mary Lee Pfeiffer.”* However, this is nothing but *“guessing” by conditional probability model the most likely following words after “Tom Cruise’s mother is.”*
 - Speaker: so we cannot say it really knows the fact!

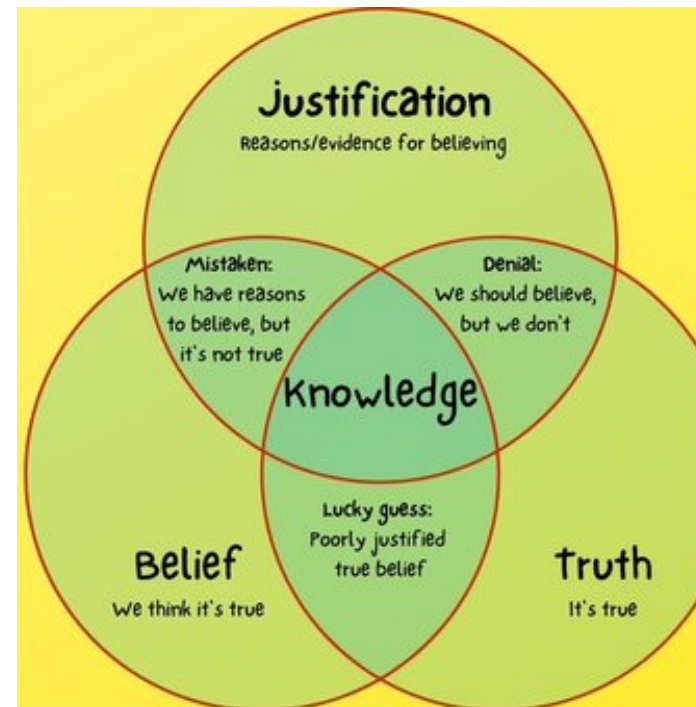

Cognitive scientific perspective on belief

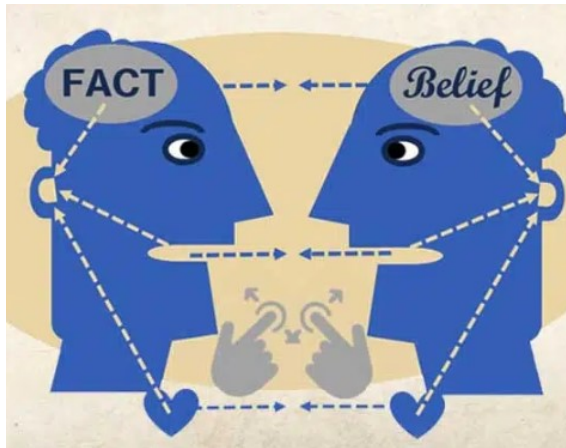

- for the discussion
 - we do not concern *any specific belief*
 - we concern prerequisites for ascribing any beliefs to AI system
- so does it have belief?
 - Speaker: nothing can count as belief about the world we share unless
 - it is against ground of the ability to update beliefs appropriately in light of evidence from that world, an essential aspect of the capacity to distinguish truth from falsehood.*
 - Speaker: when a human being takes to Wikipedia and confirms some fact, what happens is not her language model update, but *reflection of her nature as language-using animal inhabiting shared world with a community of other language-users.*
 - Speaker: LLM does not have this ground, an essential consideration when deciding whether it *really* had beliefs.
 - Speaker: so *no, LLM cannot have belief!*

Cognitive scientific perspective on reasoning

- note reasoning is *content neutral*
 - e.g., following logic is perfect regardless of truth of premises
if Socrates is a human and humen are immortal, then Socrates would have survived today.
- Speaker: when asked *“if humans are immortal, would Socrates have survived today?”*, LLM says
“ . . . it's logical to conclude that Socrates would likely still be alive today. . . . ”
 - however, remember, once again, what we just asked it to do is *not* “deductive inference”, but
given the statistical distribution of words in public corpus, what words are likely to follow the sequence, “humans are immortal and Socrates is human therefore.”
- Speaker: so LLM *cannot* or rather *does not* reason
- however, LLM can *mimic even multi-step reasoning whose inferencing structure is complicated* using *in-context learning* or *few-shot prompting!*

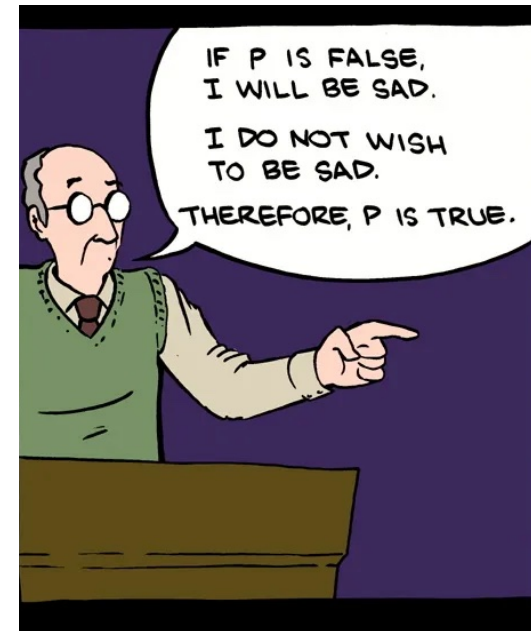

A simple example supporting reasoning incapability



- You
Who is Tom Cruise's mother?
- ChatGPT
Tom Cruise's mother is Mary Lee Pfeiffer. She was born Mary Lee South. . . . *Information about his family, including his parents, has been publicly available, . . .*
- You
Who is Mary Lee Pfeiffer's son?
- ChatGPT
As of my last knowledge update in January 2022, *I don't have specific information about Mary Lee Pfeiffer or her family, including her son. . . .*

Moral

- AI, *e.g.*, LLM, shows incredible utility and commercial potentials, hence we should
 - make informed decisions about trustworthiness and safety
 - avoid ascribing capacities they lack
- today's AI is so powerful, so (seemingly) convincingly intelligent
 - obfuscate mechanism
 - actively encourage *anthropomorphism* with philosophically loaded words like “believe” and “think”
 - easily mislead people about character and capabilities of AI
- matters not only to scientists, engineers, developers, and entrepreneurs, but also
 - *general public, policy makers, media people*

References & informants

- S. Yin, et. al., A Survey on Multimodal LLMs, 2023
- M. Shanahan, Talking About Large Language Models, 2022
 - M. Shanahan - Professor of *Cognitive* Robotics at Imperial College London
- D.P. Kingma, M. Welling. Introduction to Variational Autoencoders, 2019
- A. Vaswani, et al., Attention is all you need, NeurIPS, 2017
- I.J. Goodfellow, . . . , Y. Bengio, Generative adversarial networks (GAN), 2014
- A.Y. Halevry, P. Norvig, and F. Pereira. Unreasonable Effectiveness of Data, 2009
- Stanford Vecture Investment Groups
- CEOs & CTOs @ starup companies in Silicon Valley
- VCs on Sand Hill Road - Palo Alto, Menlo Park, Woodside in California

Thank You!